

## HUISSERIES

### Différentes dimensions d'huisseries

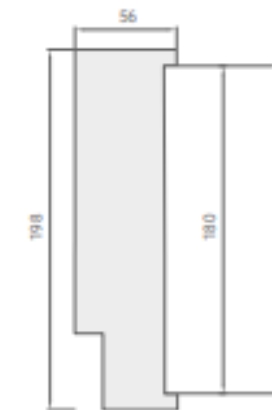
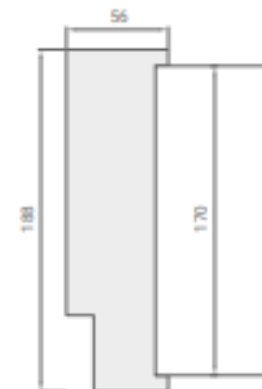
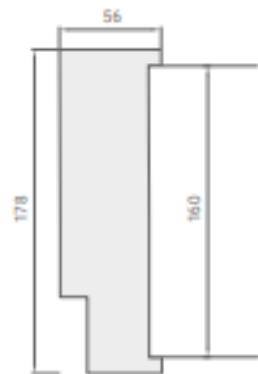
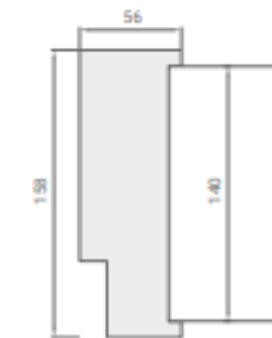
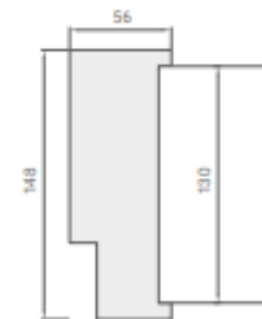
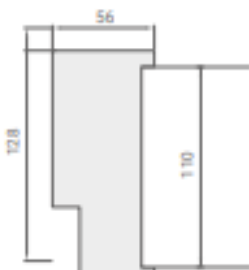
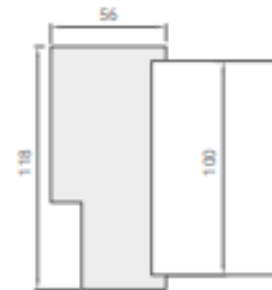
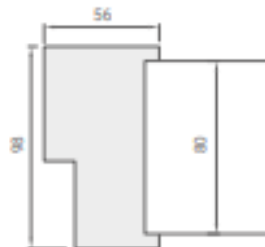
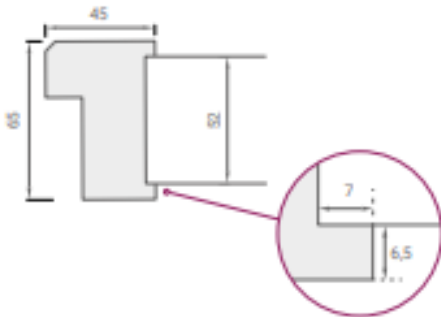

Toutes les dimensions sont exprimées en millimètre.

## HUISSERIES

### Options possibles sur les huisseries portes Chauvat

#### LE BLOC PORTE FIN DE CHANTIER LIVRÉ MONTÉ

- Huisserie 88 mm X 56 mm sans nœud prépeinte pour cloison sèche de 72 mm
- Contre chambranle en place
- 2 liteaux d'écartement fournis pour la pose
- Ces huisseries "Fin De Chantier" ne sont jamais livrées seules

	630	730	830	930
H 88 x 56				

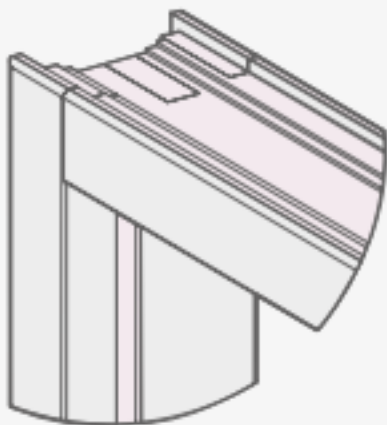
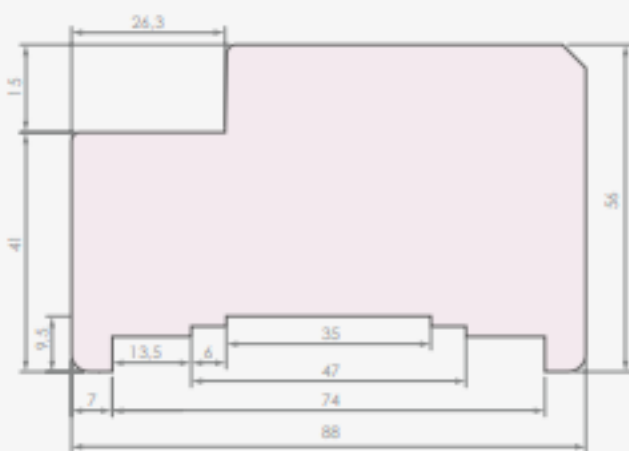

#### Focus sur les avantages de l'huisserie de dimensions 88 mm x 56 mm

Facilite la pose du rail dans l'huisserie, une rainure a été mise en place.

L'huisserie de 88 sur une cloison de 72 mm évite la pose d'un chant plat.

#### PRODUIT GAIN DE TEMPS !



#### PRÉSENTATION TECHNIQUE DE LA SOLUTION

